



*An Online CPD Course
brought to you by
CEDengineering.ca*

Wood as An Engineering Material: Adhesives with Wood Materials

Course No: S03-020
Credit: 3 PDH

Gilbert Gedeon, P.E.



Continuing Education and Development, Inc.

P: (877) 322-5800
info@cedengineering.ca

Adhesives with Wood Materials

Bond Formation and Performance

Charles R. Frihart, Research Chemist

Christopher G. Hunt, Research Chemist

Contents

Surface Properties of Wood for Bonding 10–2
Lumber Surfaces 10–2
Veneer Surfaces 10–3
Chemical Interference to Bonding 10–4
Bonding of Wood Composite Products and Nonwood Materials 10–5
Physical Properties of Wood for Bonding 10–5
Density and Porosity 10–5
Moisture Content and Dimensional Changes 10–6
Adhesives 10–8
Composition 10–8
Strength and Durability 10–9
Selection 10–10
Health and Safety 10–14
Bonding Process 10–14
Moisture Content Control 10–14
Surface Preparation 10–15
Spreading of Adhesive 10–15
Assembly and Pressing 10–16
Post-Cure Conditioning 10–17
Bonded Joints 10–18
Edge-Grain Joints 10–18
End-Grain Joints 10–18
End-to-Edge-Grain Joints 10–18
Construction Joints 10–19
Testing and Performance 10–19
Analytical, Chemical, and Mechanical Testing of Polymers 10–19
Mechanical Testing of Bonded Assemblies 10–20
Short- and Long-Term Performance 10–21
Product Quality Assurance 10–22
Standards 10–22
References 10–23

Adhesive bonding of wood plays an increasing role in the forest products industry and is a key factor for efficiently utilizing our timber resource. The main use of adhesives is in the manufacture of building materials, including plywood, oriented strandboard, particleboard, fiberboard, structural composite lumber, doors, windows and frames, and factory-laminated wood products. Adhesives are also used in the assembly of furniture and cabinets, manufacture of engineered wood products, and construction of residential and commercial structures.

Adhesives transfer and distribute loads between components, thereby increasing the strength and stiffness of wood products. Effective transfer of stress from one member to another depends on the strength of the links in an imaginary chain across the adhesive-bonded joint (Fig. 10–1). Thus, the performance of a bonded joint depends on how well the complex factors that contribute to the properties of the individual links (wood, adhesive, and interphase regions of wood and adhesive) are controlled during product assembly, which ultimately determines the strength of the chain.

Adhesion involves both mechanical and chemical factors that control the adhesive's ability to hold together two wood surfaces. Because wood is porous, one mechanism of adhesion is mechanical interlocking. Effective mechanical interlocking takes place when an adhesive penetrates beyond the surface debris and damaged fibers into sound wood two to six cells deep. Further penetration into the cell wall microstructure increases the mechanical interlocking and the surface area for adhesive contact with the wood. With many adhesives, the most durable, water-resistant bonds develop when the adhesive flows deeply into cell cavities and infiltrates inside the cell walls. The standard for excellent bonds is that the wood breaks away from the adhesive joint and that the bond strength is equal to the strength of the solid wood.

Attractive forces between molecules of adhesive and wood contribute greatly to adhesion. Although covalent bonds—chemical bonds between the adhesive and wood—seem plausible with some adhesives, no evidence exists that they contribute to the strength of adhesive bonds. However, intermolecular attractive forces, such as Van der Waal's forces,

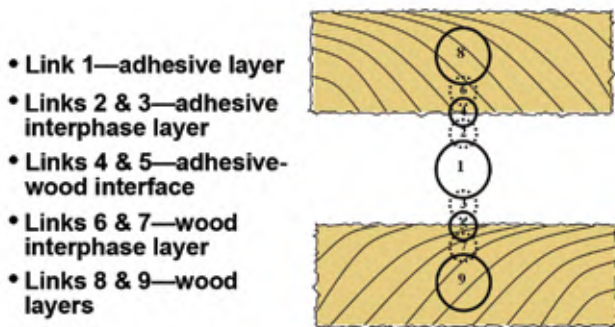

Figure 10–1. Imaginary links of adhesive bond between two pieces of wood using the schematic from Marra (1980).

dipole–dipole forces, and hydrogen bonding, occur so frequently that they must be very important for bond strength, especially given the high contact area of the adhesive with the wood. With some wood surfaces, such as teak, wood extractives can interfere with the direct adhesive contact, leading to a chemically weak boundary effect and poor bond strength.

For maximum adhesive bond strength, the liquid adhesive must “wet” the wood surface, flowing over and penetrating into the wood. Molecules of adhesive must come into direct contact with molecules of wood to provide the best mechanical interlock and intermolecular attraction between adhesive and wood. Wood surfaces may appear to be smooth and flat, but microscopic examination shows peaks, valleys, and crevices littered with loose fibers and other debris. Such surface conditions cause air pockets and blockages that prevent complete wetting by the adhesive and introduce stress concentrations when the adhesive has cured. In addition, different characteristics of wood (such as grain angle, natural defects, and extractives) lead to widely different surface energies, roughness, and chemistry. (Surface wetting is discussed in more detail in the section on Chemical Interference to Bonding.) In addition to wetting, or completely covering these different surfaces, adhesives must be fluid enough to flow into the microscopic holes, or capillary structure, of wood. Pressure enhances wetting by forcing liquid adhesive to flow over the surfaces, displace air blockages, and penetrate to the sound wood.

The adhesive bond forms once the adhesive solidifies, but full strength may take from hours to days to develop. The applied adhesive changes from liquid to solid by one or more of three mechanisms: (a) loss of solvent from adhesive through evaporation and diffusion into the wood, (b) cooling of a molten adhesive, or (c) chemical polymerization into cross-linked structures that resist softening on heating. Because water is a common carrier for most wood adhesives, loss of water and chemical polymerization often occur simultaneously.

Surface Properties of Wood for Bonding

Because adhesives bond by surface attachment, the physical and chemical conditions of the wood’s surface are extremely important to satisfactory bond performance. The wood surface should be smooth, flat, and free of machine marks and other surface irregularities, including planer skips and crushed, torn, or chipped grain. The surface should be free of burnishes, exudates, oils, dirt, and other debris that form a weak boundary between the adhesive and the wood.

Both mechanical and chemical properties of a wood surface influence the quality of adhesive bonds. Wood whose surface is highly fractured or crushed cannot form a strong bond even if the adhesive forms a strong bond with the surface. The weak wood underneath the surface is the weak link in the chain and the location of failure in the bonded assembly. In other cases, poor bond strength is due to chemical properties of the surface. Sometimes natural extractives, overdrying, or chemicals added to modify the wood alter the surface chemistry enough to harm adhesive bond performance. Physical deterioration and chemical contamination interfere with essential wetting, flow, and penetration of adhesive, and contamination sometimes interferes with the cure of the adhesive and resulting cohesive strength of the bond.

Lumber Surfaces

Surfacing or resurfacing the wood within 24 h before bonding removes extractives and provides a more wettable surface. Surfacing also removes any unevenness that may have occurred from changes in moisture content. Parallel and flat surfaces allow the adhesive to flow freely and form a uniformly thin layer that is essential to optimal adhesive performance.

Experience and testing have proven that a smooth, knife-cut surface is best for bonding. Surfaces made using saws are usually rougher than those made using planers and jointers. However, surfaces sawn with special blades on properly set straight-line ripsaws are satisfactory for both structural and nonstructural joints. Furniture manufacturers commonly use precision sawing of wood joints rather than two-step sawing and jointing to reduce costs for labor, equipment, and material. Unless the saws and feed works are well maintained, however, joints made with sawed surfaces will be weaker and less uniform in strength than those made with sharp planer or jointer knives. Dull cutting edges of planer or jointer knives crush and burnish the cells on the wood surface. Not only are these cells weaker, they also inhibit adhesive wetting and penetration. Damage to the surface can be revealed by wiping a very wet rag over a portion of the surface, waiting for a minute or more, removing any remaining water with a dry paper towel, and comparing the roughness of the wet and dry surfaces. If the wetted area

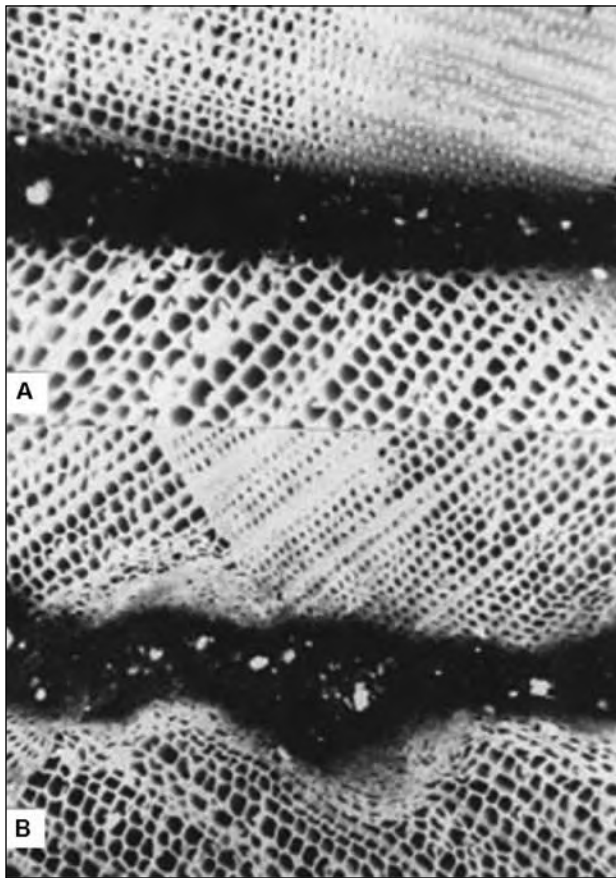

Figure 10–2. Cross sections of bonded joints involving undamaged and damaged Douglas-fir surfaces. The dark area at the center of micrograph is the adhesive bondline. Image A involves two undamaged surfaces from planing with sharp knife (120×) and shows open wood cells with their distinct walls. Image B involves two damaged surfaces abrasively planed with 36-grit sandpaper and shows crushed cells with their indistinct walls in and adjacent to the bondline.

is much rougher than the dry area, then the machining has damaged the surface. A weak joint results if the adhesive does not completely penetrate crushed cells to restore their original strength.

Abrasive planing with grit sizes from 24 to 60 causes surface and subsurface crushing of wood cells. The adhesive industry typically recommends 60–80-grit sanding as acceptable for wood bonding as this equates to 24 to 30 knife marks per inch when planing. Generally, anything above 200 grit fuzzes the wood surface and is not recommended. Figure 10–2 shows bondlines of undamaged, knife-planed Douglas-fir lumber (A) compared with bondlines between surfaces damaged by abrasive planing (B). Such damaged surfaces are inherently weak and result in poor

bond strength. If abrasive planing is to be used before bonding, belts must be kept clean and sharp, and sanding dust must be removed completely from the surface. However, abrasive planing is not recommended for structural joints that will be subjected to high swelling and shrinkage stresses from water soaking and drying.

Veneer Surfaces

The desired properties of wood veneer are essentially similar to those of lumber, but manufacturing processes, including cutting, drying, and laminating into plywood, can drastically change physical and chemical surface properties of veneer. Special knowledge and attention to these properties are required to ensure good wetting and penetration of the adhesive.

Rotary-cut veneer is produced by rotating a log by its ends against a knife, which results in continuous sheets of flat-grain veneer. As the knife peels veneer from the log, the knife forces the veneer away from the log at a sharp angle, fracturing (checking) the veneer on the knife side. The checked side is commonly called the loose side, and the opposite side without checking is called the tight side. When rotary-cut veneer is used for faces in plywood, the loose side should be bonded and the tight side finished. Otherwise, open checks in the faces produce imperfections in the finish. Adhesive overpenetration into lathe checks usually is not a problem if the adhesive spread rate is set correctly.

Sliced veneer is produced in long strips by moving a squared log, called a flitch, against a knife. As in rotary cutting, the knife forces the veneer away from the flitch at a sharp angle, causing fine checking of the veneer on the knife side. This checked surface will show imperfections in a finished surface, so the loose side should be bonded and the tight side finished. For book-matched face veneers, where grain patterns of adjacent veneers are near mirror images, half the veneers will be loosely cut and must be finished so the veneer must be cut as tightly as possible. Generally, hardwood face veneers are sliced to reveal the most attractive grain patterns.

Sawn veneer is produced in long narrow strips from flitches that have been selected and sawn for attractive grain patterns. The two sides of sawn veneer are free from knife checks, so either surface may be bonded with satisfactory results.

Veneer is dried promptly after cutting, using continuous, high-temperature dryers that are heated with either steam or hot gases from wood-residue- or gas-fired burners. Drying temperatures range from 170 to 230 °C (330 to 446 °F) for short periods. Drying to very low moisture levels at very high temperatures or at moderate temperatures for prolonged periods inactivates the veneer surfaces, causing poor wetting of veneer and hence poor bonding. Residues deposited on veneer surfaces from incomplete

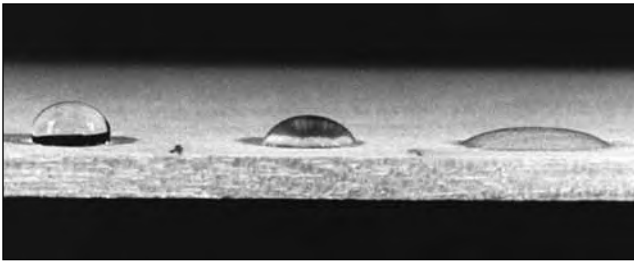

Figure 10–3. A simple water drop test shows differences in wettability of yellow birch veneer surface. Three drops were applied to surface simultaneously and then photographed after 30 s. Left drop retained a large contact angle on aged and unsanded surface; center drop had a smaller contact angle and improved wettability after the surface was renewed by two passes with 320-grit sandpaper; right drop showed a small contact angle and good wettability after four passes with the sandpaper.

combustion of gases and fuel oils can cause serious adhesion problems in plywood production.

Veneer selected for its attractive appearance, or for use in sanded grades of plywood, should be uniform in thickness, smooth, and flat; be free from deep checks, knots, holes, and decay; and have face grain suitable for the intended face grade. For lower grade plywood, defect standards are not as strict. For example, loosely cut veneer with many deep checks and large defects is suitable for structural plywood, but this veneer requires more adhesive than does tightly cut veneer.

Chemical Interference to Bonding

Chemical interference that reduces the bondability of wood is more complicated and more difficult to detect than the mechanical weakening of wood surfaces. This interference can be from natural causes (migration of extractives to the surface), inadvertent wood alteration (overdrying of the wood surface), or intentional alteration (wood modification). A simple water test can reveal much about the state of a wood surface and any difficulties for wetting and bonding with an adhesive. This test allows estimation of the degree of surface inactivation of veneer towards wetting and penetration by placing a drop of water on the wood surface and observing how fast the drop spreads over the wood. A drop of water is placed in an area on the earlywood of a flat-grain surface that does not have checks or splits. A surface with good wettability and penetrability will absorb the drop within 20 s. If the drop spreads out but some water remains on the surface after 40 s, then the surface has good wettability and poor penetration, and may be difficult to bond. If after 40 s the water drop retains much of its original shape with little spreading, then bonding problems from surface inactivation (poor wettability and penetrability) is a certainty.

Figure 10–3 shows how the inactivated surface of veneer can be removed by sanding of the surface to allow the droplet to flow into a wider droplet on the surface instead of staying as a bead.

Extractives on wood surfaces contribute to surface inactivation through both physical and chemical means. Most wood adhesives are waterborne; therefore, they do not properly wet and penetrate extractive-covered surfaces. Particularly troublesome extractives are pitch, especially in the southern pines and Douglas-fir, and oil, such as in teak. When subjected to high temperatures during processing, extractives migrate to the surface where they concentrate and physically block adhesive contact with wood. Furthermore, pitchy and oily extractives are hydrophobic (that is, they repel water). The acidity of extractives of some Southeast Asian hardwoods and oak species can interfere with the chemical cure of some adhesives. In contrast, alkaline extractives can retard normal polymerization of an acid-cured adhesive, such as urea-formaldehyde, which would compromise the integrity of the adhesive film and bond.

Overdrying and overheating interfere with adhesion by causing extractives to diffuse to the surface, by reorienting surface molecules and exposing the less polar portion, by oxidizing or pyrolyzing the wood, or by irreversibly closing the larger micropores of cell walls. Airborne chemical contaminants can also inactivate a wood surface.

To reduce decay, wood is treated with a variety of preservatives, including creosote, pentachlorophenol, chromated copper arsenate (CCA), copper azole, ammoniacal copper quat, and boron compounds. These treatments generally decrease the ability of the adhesive to wet the wood; the effect is greater with some treatments than others. Poor wetting reduces contact area and thus bond strength between adhesive and wood. In addition, some treatments are known to alter the curing of adhesives. By understanding the properties of these modified woods, adhesive companies have been able to alter the adhesives and bonding process to provide sufficiently durable products.

The most common fire-retarding chemicals used for wood are inorganic salts based on phosphorous, nitrogen, and boron. These acid salts release acid at elevated temperatures to decrease flammable volatiles and increase char in wood, thereby effectively reducing flame spread. The elevated temperature and moisture conditions of hot-press curing can release some of these acids, inhibiting the cure of alkaline phenolic adhesives. Alkaline resins can still make durable bonds after some of these treatments by priming the wood with certain alkaline aqueous solutions or by selecting resins of appropriate molecular-size distribution.

Chemical modification of wood by acetylation drastically reduces moisture-related dimensional changes and the rate of biodeterioration. Acetic anhydride reacts with the

hydroxyl groups of wood. The conversion of hydroxyl groups to acetyl groups results in a lower affinity for water. Room-temperature-curing resorcinolic and acid-catalyzed phenolic hot-press adhesives develop durable bonds to acetylated wood. Most other wood adhesives develop poorer bonds with acetylated wood than with untreated wood.

Bonding of Wood Composite Products and Nonwood Materials

The surfaces of wood composites such as plywood, oriented strandboard, particleboard, fiberboard, and hardboard generally have poor wettability relative to that of freshly cut, polar wood surfaces. Surfaces of these materials may appear glazed, indicating that they have been inactivated by pressing at high temperatures. During hot pressing, resinous extractives and added waxes migrate to the surface, adhesive on the outer surfaces of particles and fibers cures, and caul release agents remain on the surfaces—all of which reduce wetting by waterborne wood adhesives. Surfaces of composite products typically are more difficult to bond than surfaces of solid wood products. Lightly sanding with 320-grit sandpaper often improves adhesion to composite panel products having poor wettability (Fig. 10–3). Too much sanding can create an uneven surface and perhaps produce too much loose-fiber debris that can interfere with adhesion. Furthermore, the internal strength of composites often limits the strength of adhesive bonds.

Products incorporating wood composites bonded to metal or plastic are becoming more common because of property and cost advantages, but they present special challenges. Metal foils and plastic films laminated to wood composites do not require high cohesive strength for indoor applications, but the adhesives still must be compatible with both the wood and nonwood surfaces. If a structural bond is required between wood and metal or plastic, then only epoxy, polyurethane, and isocyanate-based adhesives may be sufficiently compatible. Even then, good adhesion often requires cleaning of the nonwood surfaces to remove contaminants or applying coupling agents, primers, or other special treatments to chemically activate the surfaces.

The difficulty with bonding metals to wood is usually metal surface inactivation. The surface energy of clean metals is higher than that of wood, but with exposure to air, metals quickly adsorb contaminants and form metal oxides to produce a low-energy, weak boundary layer at the surface. A series of cleaning procedures is required to regenerate the high-energy surface and create microscale roughness necessary for structural bonding. Steps in surface preparation may include abrasion by sandblasting, cleaning with liquid or vapor organic solvents, alkaline washing, chemical etching, and/or priming with adhesive solutions or coupling agents.

Plastic surfaces are difficult to bond because they are generally low energy, nonpolar, and hydrophobic. Plastics are

organic polymers that may be either thermoplastic (soften on heating) or thermosetting (cross-linked and resist softening on heating). Thermoplastics generally are not as strong and stiff as wood, but the properties of thermoset materials approximate and even exceed the mechanical properties of wood. When plastics containing fibrous reinforcing materials such as fiberglass are bonded to woods, strength and stiffness of the composite materials can be greater than that of wood. Reinforced plastics that are effectively bonded to wood offer strong and cost-effective structural composites. Traditional waterborne wood adhesives do not bond well to plastics because they are polar and hydrophilic. Epoxies, polyurethanes, and isocyanate-based adhesives are capable of bonding many plastics to wood. Adhesion to plastic surfaces occurs primarily by physical intermolecular attraction forces and, in some cases, hydrogen bonding. Abrading and chemical etching of plastic surfaces increase adhesion by providing some mechanical interlocking. Coupling agents have molecules that are capable of reacting with both the adhesive and the surface, making them particularly useful for bridging dissimilar materials. Plasma treatment of plastic surfaces can clean and activate surfaces for enhanced adhesion. Grafting of monomers onto cleaned plastic surfaces by means of plasma polymerization creates a polar surface that is more compatible with adhesives.

Physical Properties of Wood for Bonding

Density and Porosity

Surface properties are not the only factors to control bonding in wood. Bond quality is also affected by the bulk physical properties of wood, particularly density, porosity, moisture content, strength, and swelling–shrinking properties.

Solid wood cell walls have a density of $1,500 \text{ kg m}^{-3}$ (94 lb ft^{-3}), regardless of the wood species. However, density varies greatly with void volume and thickness of cell walls between wood species and within a species, and between earlywood and latewood growth (as discussed in Chap. 3). High-density wood has thick walls and small lumina, whereas low-density wood has thin walls and large lumina. Thus, higher density wood contains more material per unit of volume and can carry more load.

Adhesively bonded wood assemblies typically increase in strength with wood density up to a range of 700 to 800 kg m^{-3} (44 to 50 lb ft^{-3}) (moisture content 12%). Below this level, adhesion is usually easy and the strength of the wood limits the assembly strength. Above this level, high-strength joints with high wood failure are hard to produce consistently. Wood failure refers to the percentage of the total failure area that is wood, rather than adhesive. High wood failure is preferred because the load design values can be based upon the known wood strength and not reduced because of the quality of the bondline.

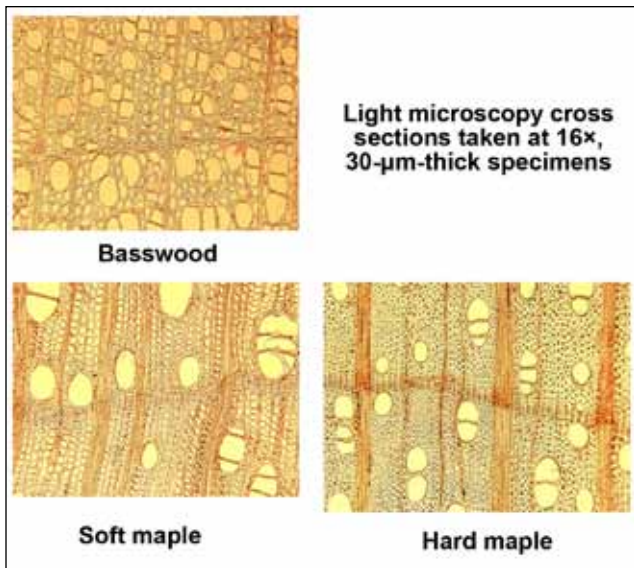

Figure 10–4. Cross sections of three different species showing openness of cellular structure. Basswood is in the “bond easily” category in Table 10–1, soft maple “bond well,” and hard maple “bond satisfactorily.” The more easily bonded wood has greater lumen volume for adhesive penetration and less cell wall volume. The lower density of the basswood compared with the hard maple makes the wood weak, and therefore less force can be applied to the bondline.

High-density woods are difficult to bond for several reasons. Because of their thicker cell walls and smaller diameter lumens, adhesives do not easily penetrate into the wood, limiting mechanical interlock to less than two cells deep. Much greater pressure is required to compress stronger, stiffer, high-density wood to bring contact between wood surfaces and adhesive. Higher concentration of extractives that may interfere with the cure of adhesives is common in high-density species, particularly domestic oaks and imported tropical hardwoods. High-density woods are strong and allow high loads to be placed upon the bondline. Finally, high-density woods tend to swell and shrink more with changes in moisture content than do low-density woods.

Density is perhaps a crude indicator, but as previously noted, it is useful for estimating the bondability of a great variety of wood species. Table 10–1 categorizes commonly used domestic and imported species according to their relative ease of bonding. The bondability categories for domestic woods are based on the average strength of side-grain joints of lumber as determined in laboratory tests and industrial experience. The laboratory tests included animal, casein, starch, urea-formaldehyde, and resorcinol-formaldehyde adhesives. The categories for imported woods are based on information found in the literature on bond strength, species properties, extractives content, and industrial experience.

In most cases, fewer data are available for imported woods than domestic woods. Beware that a species that bonds poorly with one adhesive may develop much better bonds with another adhesive. A similar type of adhesive with somewhat different working, penetration, curing, and even strength properties can often dramatically improve bondability of a given species. Adhesive suppliers quite often adjust adhesive formulations to solve specific adhesion problems.

Wood density and anatomy control wood porosity, which usually affects penetration and bond performance. To attain the highest joint strength, the adhesive must penetrate and interlock several cells deep into sound, undamaged cell structure. In wood, porosity varies according to the grain direction. End-grain surfaces are many times more porous than radial or tangential surfaces. Adhesives penetrate so easily into the open lumens along the grain that overpenetration often occurs when gluing end-grain. This overpenetration is a primary reason why it is so difficult to form strong, load-bearing bonds in butt joints. Across the grain, paths for adhesive flow are fewer and smaller, so overpenetration generally is not a problem with a properly formulated adhesive.

The porosity and resulting adhesive flow into wood varies greatly, both between hardwoods and softwoods and within each of these groups. In Figure 10–4, cross-section micrographs demonstrate the large differences in lumen volume between three diffuse-porous hardwood species. Softwoods have longitudinal tracheid lumens connected by bordered pits. Pits are the small openings between fibers that permit lateral transfer of fluids in living trees. Adhesives might use the network of pits to penetrate deeply, even in tangential and radial directions. In hardwoods, the thin-walled, relatively large longitudinal vessels have porous end walls, so adhesive can penetrate deeply along the end grain. Where two vessels are in lateral contact, multiple inter-vessel pitting can occur, which allows for lateral flow between vessels. The remaining thick-walled fibers have relatively few pits for lateral transfer of adhesive. Some species, such as red oaks, have large numbers of radially oriented rays that can allow excessive flow and overpenetration. Adhesives provided for customers who use large volume are specifically formulated for hardwoods or softwoods, and for specific species within the groups, and have adjustable properties for specific manufacturing situations.

Moisture Content and Dimensional Changes

Water occurs naturally in living trees and affects wood properties and adhesive bond strength dramatically. Depending on extractives levels and wood chemistry, wood can typically take up 25% to 30% of its dry weight in water. The point at which wood cannot adsorb any more water is called the fiber saturation point. As wood dries below the fiber saturation point, it begins to shrink and become stiffer. Above the fiber saturation point, excess water simply fills lumens and makes wood heavier. Wood in service will

Table 10–1. Categories of selected wood species according to ease of bonding

U.S. hardwoods	U.S. softwoods	Imported woods	
Bond easily^a			
Alder	Fir	Balsa	Hura
Aspen	White	Cativo	Purpleheart
Basswood	Grand	Courbaril	Roble
Cottonwood	Noble	Determa ^b	
Chestnut, American	Pacific		
Magnolia	Pine		
Willow, black	Eastern white		
	Western white		
	Redcedar, western		
	Redwood		
	Spruce, Sitka		
Bond well^c			
Butternut	Douglas-fir	Afromosia	Meranti (lauan)
Elm	Larch, western ^d	Andiroba	Light red
American	Pine	Angelique	White
Rock	Sugar	Avodire	Yellow
Hackberry	Ponderosa	Banak	Obeche
Maple, soft	Redcedar, eastern	Iroko	Okoume
Sweetgum		Jarrah	Opepe
Sycamore		Limba	Peroba rosa
Tupelo		Mahogany	Sapele
Walnut, black		African	Spanish-cedar
Yellow-poplar		American	Sucupira
			Wallaba
Bond satisfactorily^e			
Ash, white	Yellow-cedar	Angelin	Meranti (lauan), dark red
Beech, American	Port-Orford-cedar	Azobe	Pau marfim
Birch	Pines, southern	Benge	Parana-pine
Sweet		Bubinga	Pine
Yellow		Karri	Caribbean
Cherry			Radiata
Hickory			Ramin
Pecan			
True			
Madrone			
Maple, hard			
Oak			
Red ^b			
White ^b			
Bond with difficulty^f			
Osage-orange		Balata	Keruing
Persimmon		Balau	Lapacho
		Greenheart	Lignumvitae
		Kaneelhart	Rosewood
		Kapur	Teak

^aBond very easily with adhesives of a wide range of properties and under a wide range of bonding conditions.

^bDifficult to bond with some phenol-formaldehyde adhesives.

^cBond well with a fairly wide range of adhesives under a moderately wide range of bonding conditions.

^dWood from butt logs with high extractive content is difficult to bond.

^eBond satisfactorily with good-quality adhesives under well-controlled bonding conditions.

^fSatisfactory results require careful selection of adhesives and very close control of bonding conditions; may require special surface treatment.

shrink and swell as it loses and gains moisture from the air; under typical indoor conditions, wood contains 5% to 12% moisture. The shrinking and swelling (dimensional changes) are different for the three principal directions in wood. Longitudinal dimensional change (along the grain, or up and down in the standing tree) is the least and amounts to less than 1% between fiber saturation and oven-dry. Tangential dimensional change is the greatest, typically 6% to 12%, while radial dimensional change is typically about half of the tangential movement. Wood with low density tends to have the smallest dimensional change. Chapter 4 provides a detailed discussion of wood–moisture relations.

Wood dimensional changes that accompany changes in moisture content have broad-ranging and important consequences on the performance of bonded joints. As wood in bonded assemblies swells and shrinks, stresses develop that can damage the adhesive bond or wood. Damage may occur when moisture content changes in adjacent pieces of wood that have different swelling or shrinkage coefficients. This can arise with different species, different heartwood, sapwood, or juvenile wood content, or grain type, such as radial grain bonded to tangential or end grain bonded to cross grain. Even more stressful is when only one part of an assembly changes moisture content. Dimensional changes associated with water are a common cause of adhesive failure. Moisture-driven stresses can be minimized by bonding pieces of wood with compatible grain directions and low shrinkage coefficients and by bonding at the moisture content expected during service.

The moisture in wood combined with water in adhesive will greatly influence the wetting, flow, penetration, and cure of waterborne wood adhesives. In general, optimum adhesive properties occur when the wood is between 6% and 14% moisture content. Special formulations are often used outside this range. Aqueous adhesives tend to dry out when applied to wood below 6% moisture content. Wood absorbs water from the adhesive so quickly that adhesive flow and penetration into the wood are drastically inhibited, even under high pressure. Wood may become so dry below 3% moisture content that it temporarily resists wetting.

Wood with too much moisture is also difficult to bond with normal waterborne adhesives. Water and low-molecular-weight portions of the adhesive migrate less effectively into wet wood cell walls than into drier cell walls. This leaves the adhesive more runny and prone to squeeze-out when pressure is applied. The extra adhesive mobility can also lead to overpenetration and starvation of the bond. In many adhesives, low-molecular-weight components infiltrating the cell walls are necessary for long-term durability. Control of moisture content is particularly critical when adhesive is cured in a hot press because the excess moisture turns to high-pressure steam inside the product. This pressurized steam can blast channels through the wood product or cause

large internal voids, called blows, in panel products. Even if blows do not occur, excess moisture within thermosetting adhesives can prevent complete cross linking, thereby weakening the adhesive. Appropriate moisture content levels of wood for bonding by hot-press methods are well known, as are target moisture content levels for wood products throughout the United States. However, controlling moisture content during bonding of wood materials is not always easy (as discussed in the Moisture Content Control section).

Adhesives

Composition

During the 20th century, wood adhesives shifted from natural to synthetic organic polymers. A polymer is a large molecule constructed of many small repeated units. Natural polysaccharide and protein polymers in blood, hide, casein, soybean, starch, dextrin, and other biomass have been used as adhesives for centuries. These polymers are still in use today, although they have been largely replaced by petrochemical and natural-gas-based systems. The first wood adhesives based on synthetic polymers were produced commercially during the 1930s. Synthetic polymers can be made stronger, more rigid, and more durable than wood, and they generally have much greater water resistance than do traditional adhesives from natural polymers. However, recent advances in biomass-based adhesives have made them more competitive with fossil-fuel-based adhesives than are traditional ones.

Whether a synthetic adhesive is thermoplastic or thermosetting has a major influence on its performance in service. Thermoplastics are long-chain polymers that soften and flow on heating and then harden again upon cooling. They generally have less resistance to heat, moisture, and long-term static loading than do thermosetting polymers. Common thermoplastic adhesives for wood include poly(vinyl acetate) emulsions, elastomeric, contact, and hot-melts. Thermosetting polymers make excellent structural adhesives because they undergo irreversible chemical change when cured, and on reheating, they do not soften and flow again. They form cross-linked polymers that can have high strength, have resistance to moisture and other chemicals, and are rigid enough to support high, long-term static loads without deforming. Phenol-formaldehyde, resorcinol-formaldehyde, melamine-formaldehyde, urea-formaldehyde, isocyanate, and epoxy adhesives are examples of thermosetting polymers.

When delivered, adhesives usually contain a mixture of several chemically active and inert materials, each added for specific properties such as working characteristics, strength properties, shelf life, or durability. Solvents dissolve or disperse adhesive polymers, act as carriers of polymer and additives, aid in wetting, and control flow and penetration of

the adhesive. Water is the carrier for most wood adhesives, primarily because water readily absorbs into wood, is inexpensive, and does not have adverse effects on the environment. Organic solvents are still used with elastomeric and contact adhesives, although waterborne adhesive systems are becoming more important in these markets as well. Reinforcing fibers, mostly inert organics, can enhance mechanical properties of the adhesive film, especially toughness, impact resistance, and shrinkage. Fillers of both organic and inorganic origins contribute to rheological control of the fluid system, particularly in reducing the spreading and penetrating of the adhesive into wood. Extenders are like fillers, in that they control flow and working characteristics, but are different in that they do not reduce bond strength.

Certain chemicals are added to plasticize adhesive polymers, enhance tackiness, improve heat resistance, or lower costs. Plasticizers, for example dibutyl phthalate, are used to soften the brittle vinyl acetate homopolymer in poly(vinyl acetate) emulsion adhesives. This is necessary to facilitate adhesive spreading and formation of a flexible adhesive film from the emulsion at and below room temperature. Phenolic polymers are used as tackifiers and adhesion promoters in neoprene and nitrile rubber contact adhesives. Reactive polymeric fortifiers, such as melamine-formaldehyde, can be substituted into urea-formaldehyde adhesives to improve resistance to moisture and heat. Substituting phenol-formaldehyde for resorcinol-formaldehyde reduces adhesive costs without sacrificing adhesive strength and durability.

Catalysts are chemicals used to accelerate the rate of chemical reaction of polymeric components. Acids, bases, salts, peroxides, and sulfur compounds are a few examples of catalysts. Catalysts do not become a part of the reacted compound; they simply increase the rate of reaction. Usually, hardeners are added to base polymers as reactive components, and they do become a part of the reacted compound. Examples are an amine hardener added to epoxy and formaldehyde added to resorcinol—both produce cross-linking reactions to solidify the adhesive. For curing urea-formaldehyde and melamine-formaldehyde adhesives, hardeners are actually catalysts in that they cure the adhesive but do not become part of the polymer. Other chemicals, such as antioxidants, acid scavengers, preservatives, wetting agents, defoamers, or colorants, may be added to control or eliminate some of the less desirable characteristics of certain adhesive formulations.

Strength and Durability

Table 10–2 loosely classifies adhesives according to how much load they can bear and how long they can sustain the load without deforming when exposed to water, heat, or other environmental conditions. In building construction, adhesives that contribute strength and stiffness to the structure during its life are considered structural. These adhesives generally are stronger and stiffer than the wood that they

bond. Structural bonds are critical because bond failure could result in serious damage to the structure or its occupants. Examples of structural applications include glued-laminated beams, prefabricated I-joists, and stressed-skin panels. Structural adhesives that maintain their strength and rigidity under the most severe cyclic water saturation and drying are considered fully exterior adhesives. Adhesives that degrade faster than wood under severe conditions, particularly water exposure, are considered interior adhesives. Between exterior and interior adhesives are the intermediate adhesives, which maintain strength and rigidity in short-term water soaking but deteriorate faster than wood during long-term exposure to water and heat. Unfortunately, adhesives that are the strongest, most rigid, and most resistant to deterioration in service are typically the least tolerant of wide variations in wood surface condition, wood moisture content, and assembly conditions, including pressures, temperatures, and curing conditions.

Semistructural adhesives impart strength and stiffness to an adhesive-bonded assembly, and in some instances, they may be as strong and rigid as wood. However, semistructural adhesives generally do not withstand long-term static loading without deformation. They are capable of short-term exposure to water although some do not withstand long-term saturation, hence their limited exterior classification. Another semistructural adhesive application is the nailed–glued assembly where failure of the bond would not cause serious loss of structural integrity because the load would be carried by mechanical fasteners.

Nonstructural adhesives typically support the dead weight of the material being bonded and can equal the strength and rigidity of wood in the dry condition. On exposure to water or high humidity, most nonstructural adhesives continue to support the weight of the material sufficiently, though a few lose the ability to transfer load. A major market for nonstructural adhesives is furniture assembly.

Elastomeric construction adhesives are categorized as nonstructural but are normally used for field assembly of panelized floor and wall systems in the light-frame construction industry. These adhesive joints are much stiffer than mechanically fastened joints, resulting in stiffer panels. In addition to the adhesive, mechanical fasteners are used to carry the load in case of adhesive failure.

Some adhesives listed in Table 10–2 could be easily included in more than one category because they can be formulated for a broad range of applications. Isocyanate and polyurethane adhesives are examples. Polymeric methylene diphenyl diisocyanate, with a low molecular weight, develops highly durable bonds in structural strandboard, even though strandboard products deteriorate from swelling and shrinkage stresses. One-part polyurethane adhesives have highly durable adhesive films, but as molecular weight

Table 10–2. Wood adhesives categorized according to their expected structural performance at various levels of environmental exposure^{a,b}

Structural integrity	Service environment	Adhesive type
Structural	Fully exterior (withstands long-term water soaking and drying)	Phenol-formaldehyde
		Resorcinol-formaldehyde
		Phenol-resorcinol-formaldehyde
		Emulsion polymer isocyanate
Limited exterior (withstands short-term water soaking)	Interior (withstands short-term high humidity)	Melamine-formaldehyde
		Isocyanate
		Melamine-urea-formaldehyde
Semistructural	Limited exterior	Epoxy
		Polyurethane
Nonstructural	Interior	Urea-formaldehyde
		Casein
		Cross-linked poly(vinyl acetate)
		Cross-linked soybean
		Poly(vinyl acetate)
		Animal
Elastomeric construction		
Elastomeric contact		
Hot-melt		
Starch		

^aAssignment of an adhesive type to only one structural/service environment category does not exclude certain adhesive formulations from falling into the next higher or lower category.

^bPriming wood surfaces with hydroxymethylated resorcinol coupling agent improves resistance to delamination of epoxy, isocyanate, emulsion polymer isocyanate, melamine and urea, phenolic, and resorcinolic adhesives in exterior service environment, particularly bonds to treated lumber.

increases, adhesion to porous wood generally decreases and bonds become increasingly susceptible to deterioration from swelling and shrinkage stresses. Soybean-based adhesives have limited wet strength on their own, but cross-linking agents can be added to increase water resistance.

Selection

Many factors need to be considered when selecting the best adhesive for a particular application. The adhesive must be applied, wet the surface, penetrate into the wood, cure, and maintain strength for sufficient time under different loads and environmental conditions. Table 10–3 describes the typical form, properties, preparation, and uses of many adhesive families, though considerable variation may occur within each family. A manufacturer and adhesive supplier should completely review the product, its intended service environment, and all production processes and equipment before choosing an appropriate adhesive. Whatever the approach to adhesive selection might be, the following points are important.

Strength—The amount of load the adhesive will be required to carry must be considered.

Durability—The kind of environment the bond will be exposed to (liquid water, humidity, heat, cold, chemicals, light, loading level) and the length of exposure will determine durability.

Wetting—As discussed in the introduction, the chemistry of the surface and adhesive must be compatible. A waterborne adhesive on an oily surface is unlikely to spread out unless the adhesive contains surfactants, organic solvents, or other materials to help it spread and make molecular contact with the surface.

Timing—Several timing factors must be considered. Pot life relates to the duration of time before the adhesive is applied to the wood. Open time is the time between applying the adhesive and joining the pieces. Closed time refers to the time between joining the pieces and applying pressure. Clamp time is determined by the duration of set time until the finished piece can be unclamped. Increasing temperature usually shortens set and cure time. Emulsion polymer isocyanates set very rapidly, which is an advantage in wood I-beam assembly. After hot or cold pressing, adhesives typically need hours or weeks to completely cure.

Consistency—The consistency, or viscosity, of the adhesive must be compatible with the application equipment, whether it be brush, spatula, extruder, curtain coater, spray, or powder metering device. In addition, the adhesive must be fluid enough to enter the void spaces in the wood but not so fluid that most of the adhesive is squeezed out of the bondline, causing a starved joint.

Mixing—If water, a hardener, catalyst, filler, or extender must be mixed with a resin, appropriate equipment must be available.

Table 10–3. Working and strength properties of adhesives, with typical uses

Type	Form and color	Preparation and application	Strength properties	Typical uses
Natural origin				
Animal, protein	Solid and liquid; brown to white bondline	Solid form added to water, soaked, and melted; adhesive kept warm during application; liquid form applied directly; both pressed at room temperature; bonding process must be adjusted for small changes in temperature	High dry strength; low resistance to water and damp atmosphere	Assembly of furniture and stringed instruments; repairs of antique furniture
Blood, protein	Solid and partially dried whole blood; dark red to black bondline	Mixed with cold water, lime, caustic soda, and other chemicals; applied at room temperature; pressed either at room temperature or 120 °C (250 °F) and higher	High dry strength; moderate resistance to water and damp atmosphere and to microorganisms	Interior-type softwood plywood, sometimes in combination with soybean adhesive; mostly replaced by phenolic adhesive
Casein, protein	Powder with added chemicals; white to tan bondline	Dissolved in water under basic conditions; applied and pressed at room temperature	High dry strength; moderate resistance to water, damp atmospheres, and high temperatures; not suitable for exterior uses	Mainly in interior doors, especially fire doors; used in laminated timbers
Cross-linked soybean, protein	Powder or dispersion with added chemicals; white to tan, similar color in bondline	Either dissolve the solid in water with other added chemicals or use a pre-dispersed soy, mix with cross linker prior to application; cured in hot press at 120 to 150 °C (250 to 300 °F)	Good dry strength and decent resistance to water and damp atmospheres; good resistance to elevated temperatures	Decorative plywood for interior use, laminated flooring, particleboard, and oriented strandboard
Lignins and tannins	Powder or liquid; may be blended with phenolic adhesive; dark brown bondline	Blended with extender and filler by user; adhesive cured in hot-press 130 to 150 °C (266 to 300 °F) similar to phenolic adhesive	Good dry strength; moderate to good wet strength; durability improved by blending with phenolic adhesive	Partial replacement for phenolic adhesive in composite and plywood panel products
Soybean, protein	Powder with added chemicals; white to tan, similar color in bondline	Mixed with cold water, lime, caustic soda, and other chemicals; applied and pressed at room temperatures, but more frequently hot pressed when blended with blood adhesive	Moderate to low dry strength; moderate to low resistance to water and damp atmospheres; moderate resistance to intermediate temperatures	Decorative plywood for interior use; combinations with phenolics gives good moisture durability
Synthetic origin				
Cross-linked poly(vinyl acetate) emulsion	Liquid, similar to poly(vinyl acetate) emulsions but includes copolymers capable of cross linking with a separate catalyst; white to tan with colorless bondline	Liquid emulsion mixed with catalyst; cure at room temperature or at elevated temperature in hot press and radio-frequency press	High dry strength; improved resistance to warm temperatures and moisture, particularly long-term performance in moist environment	Interior and exterior doors; molding and architectural woodwork; cellulosic overlays
Elastomeric contact	Viscous liquid, typically neoprene or styrene-butadine elastomers in organic solvent or water emulsion; tan to yellow	Liquid applied directly to both surfaces, partially dried after spreading and before pressing; roller-pressing at room temperature produces instant bonding	Strength develops immediately upon pressing, increases slowly over a period of weeks; dry strengths much lower than those of conventional wood adhesives; low resistance to water and damp atmospheres; adhesive film readily yields under static load	On-the-job bonding of decorative tops to kitchen counters; factory lamination of wood, paper, metal, and plastic sheet materials

Table 10–3. Working and strength properties of adhesives, with typical uses—con.

Type	Form and color	Preparation and application	Strength properties	Typical uses
Elastomeric mastic (construction adhesive)	Putty-like consistency, synthetic or natural elastomers in organic solvent or latex emulsions; tan, yellow, gray	Mastic extruded in bead to framing members by caulking gun or like pressure equipment; nailing required to hold materials in place during setting and service	Strength develops slowly over several weeks; dry strength lower than conventional wood adhesives; resistant to water and moist atmospheres; tolerant of outdoor assembly conditions; gap-filling; nailing required to ensure structural integrity	Lumber to plywood or strandboard in floor and wall systems; laminating gypsum board and rigid foam insulating; assembly of panel system in manufactured homes
Emulsion polymer isocyanate	Liquid emulsion and separate isocyanate hardener; white with hardener; colorless bondline	Emulsion and hardener mixed by user; reactive on mixing with controllable pot-life and curing time; cured at room and elevated temperatures; radio-frequency curable; high pressure required	High dry and wet strength; very resistant to water and damp atmosphere; very resistant to prolonged and repeated wetting and drying; adheres to metals and plastics	Laminated beams for interior and exterior use; lamination of plywood to steel metals and plastics; doors and architectural materials
Epoxy	Liquid resin and hardener supplied as two parts; completely reactive, mainly solvent-free; clear to amber; colorless bondline	Resin and hardener mixed by user; reactive with limited pot-life; cured at room or elevated temperatures; only low pressure required for bond development	High dry and wet strength to wood, metal, glass, and plastic; formulations for wood resist water and damp atmospheres; delaminate with repeated wetting and drying; gap-filling	Laminating veneer and lumber in cold-molded wood boat hulls; assembly of wood components in aircraft; lamination of architectural railings and posts; repair of laminated wood beams and architectural building components; laminating sports equipment; general purpose home and shop
Hot melt	Solid blocks, pellets, ribbons, rods, or films; solvent-free; white to tan; near colorless bondline	Solid form melted for spreading; bond formed on solidification; requires special application equipment for controlling melt and flow	Develops strength quickly on cooling; lower strength than conventional wood adhesives; moderate resistance to moisture; gap-filling with minimal penetration	Edge-banding of panels; plastic lamination; patching; film and paper overlays; furniture assembly; general purpose home and shop
Isocyanate	Liquid containing monomers and oligomers of methylene diphenyl diisocyanate; light brown liquid and clear bondline	Adhesive applied directly by spray; reactive with water; requires high temperature and high pressure for best bond development in flakeboards	High dry and wet strength; very resistant to water and damp atmosphere; adheres to metals and plastics	Flakeboards; particleboard, strand-wood products
Melamine- and melamine-urea-formaldehyde	Powder with blended catalyst; may be blended up to 40% with urea; white to tan; colorless bondline	Dissolved in water; cured in hot press with platens at 120 to 150 °C (250 to 300 °F) and lower internal temperatures; particularly suited for fast curing in high-frequency presses	High dry and wet strength; very resistant to water and damp atmospheres	Melamine–urea-formaldehyde primary adhesive for durable bonds in hardwood plywood; end-jointing and edge-gluing of lumber; and scarf joining softwood plywood, ultra-low emitting form-aldehyde adhesive for particleboard and fiberboard

Table 10–3. Working and strength properties of adhesives, with typical uses—con.

Type	Form and color	Preparation and application	Strength properties	Typical uses
Phenol-formaldehyde	Liquid, powder, and dry film; dark red bondline	Liquid blended with extenders and fillers by user; film inserted directly between laminates; liquid or powder applied directly to flakes in composites; all formulations cured in hot press at 120 to 150 °C (250 to 300 °F) up to 200 °C (392 °F) in flakeboards	High dry and wet strength; very resistant to water and damp atmospheres; more resistant than wood to high temperatures and chemical aging	Primary adhesive for exterior softwood plywood, flakeboard, hardboard, and low emission particleboard
Poly(vinyl acetate) emulsion	Liquid ready to use; often polymerized with other polymers; white to tan to yellow; colorless bondline	Liquid applied directly; pressed at room temperatures and in high-frequency press	High dry strength; low resistance to moisture and elevated temperatures; joints yield under continued stress	Furniture; flush doors; plastic laminates; panelized floor and wall systems in manufactured housing; general purpose in home and shop
Polyurethane	Low viscosity liquid to high viscosity mastic; supplied as one-part or two-part systems; completely reactive; color varies from clear to brown; colorless bondline	Adhesive applied directly to one surface, preferably to water-misted surface; reactive with moisture on surface and in air; cures at room temperature; high pressure required, but mastic required only pressure from nailing	High dry and wet strength; resistant to water and damp atmosphere; limited resistance to prolonged and repeated wetting and drying; gap-filling	General purpose home and shop; construction adhesive for panelized floor and wall systems; laminating plywood to metal and plastic sheet materials; specialty laminates; installation of gypsum board
Resorcinol- and phenol-resorcinol-formaldehyde	Liquid resin and powdered hardener supplied as two parts; phenol may be copolymerized with resorcinol; dark red bondline	Liquid mixed with powdered or liquid hardener; resorcinol adhesives cure at room temperatures; phenol-resorcinols cure at temperatures from 21 to 66 °C (70 to 150 °F)	High dry and wet strength; very resistant to moisture and damp atmospheres; more resistant than wood to high temperature and chemical aging	Primary adhesives for laminated timbers and assembly joints that must withstand severe service conditions
Urea-formaldehyde	Powder and liquid forms; may be blended with melamine or other more durable resins; white to tan resin with colorless bondline	Powder mixed with water, hardener, filler, and extender by user; some formulations cure at room temperatures, others require hot pressing at about 120 °C (250 °F) for plywood and 210 °C (410 °F) for fiberboard and particleboard; curable with high-frequency heating	High dry and wet strength; moderately durable under damp atmospheres; moderate to low resistance to temperatures in excess of 50 °C (122 °F)	Hardwood plywood; furniture; medium density fiberboard; particleboard; underlayment; flush doors; furniture cores

Pressure—Pressure is applied to joints to ensure close contact between the parts. Typically, most wood adhesives do not fill gaps well and so require high pressure. Pressure also helps the adhesive to wet and penetrate the wood surface by forcing it into the void spaces of wood. However, too high a pressure, such that the adhesive largely squeezes out, should be avoided.

Temperature—The adhesive should work under different temperature conditions. The temperature of the surrounding environment can affect adhesive pot life, duration of open time, and curing. Phenol-formaldehyde, melamine-formaldehyde, urea-formaldehyde, and isocyanate adhesives must be cured at high temperatures and require expensive, heated presses. Some of these are cured within minutes in

expensive, high-frequency, heated presses. Emulsion polymer isocyanates, poly(vinyl acetate), epoxy, polyurethanes, and resorcinol-containing adhesives cure well at room temperatures.

Moisture content—Many adhesives need low wood moisture content to penetrate the wood. However, isocyanates and polyurethanes are less sensitive and may even perform better at higher moisture contents.

Color and finishing properties—In furniture and interior millwork where appearance is critical, adhesive color, ability to absorb stains and finishes, and freedom from bleeding and staining are critical factors. Adhesives used in the furniture industry are usually formulated to produce a tan or colorless joint.

Ease and simplicity—One-part adhesives, such as poly(vinyl acetate), one-part polyurethane, hot-melt, and phenol-formaldehyde, are the simplest to use because there is no chance for error in weighing and mixing components. Waterborne adhesives are easy to clean up. Two- or multiple-part adhesives require careful measuring and mixing of components and often require special solvents for cleanup after bonding. High water resistance often means more difficult cleanup when cured.

Cost—Given that adhesives are more expensive than the wood, the cost of adhesive and cost of related application equipment and labor must all be considered.

Safety and environment—Many adhesives cure by chemical reactions and therefore are hazardous in the uncured state. Even waterborne adhesives can have organic chemical components that evaporate, causing health concerns for workers and consumers. Frequently, adhesives are toxic to the skin or give off toxic fumes. Formaldehyde hardener for resorcinol, phenol, melamine, and urea adhesives is a severe irritant. Amine hardeners in some epoxy adhesives are strong skin sensitizers. Chemical sensitivity can be caused by repeated exposure to uncured adhesives. State and Federal regulations continue to require adhesives suppliers to reduce air emissions. In recent years, the cost of organic solvents and the cost of recovering volatiles to prevent air pollution have increased. Substitute waterborne systems can be less expensive because of the low cost of the water solvent; however, raising of the wood grain, slower drying, and final product performance must be considered.

Health and Safety

Uncured adhesives can be harmful and require safety precautions, while cured adhesives are usually safe for human contact. A notable exception is urea-formaldehyde adhesive, which can release low concentrations of formaldehyde gas from bonded wood products, especially under hot, moist conditions. **Formaldehyde** can react with proteins of the body to cause irritation and inflammation of membranes of eyes, nose, and throat, and may be a carcinogen. Driven by regulations mandating lower formaldehyde emissions, considerable research has led to new adhesive formulations with significantly reduced levels of formaldehyde emissions in both manufacturing operations and bonded wood products. New standards in the United States and other countries have reduced the acceptable upper limit for formaldehyde emissions. Phenol(resorcinol)-formaldehyde adhesives, which are used to manufacture plywood, strandboard, and laminated beams, also contain formaldehyde. However, the highly durable phenol-formaldehyde, resorcinol-formaldehyde, and phenol-resorcinol-formaldehyde polymers do not chemically break down in service; thus, no detectable formaldehyde is released. Although not quite as durable in bond strength as the phenolics, melamine-formaldehyde polymers do not break down to yield formaldehyde. New ultra-low emitting formaldehyde (**ULEF**) adhesives are formulated

to reduce formaldehyde emissions. Poly(vinyl acetate), isocyanate, and soy adhesives address the formaldehyde issue by being no added formaldehyde (**NAF**). Unless detailed knowledge of the safety of the adhesive is available, it should be assumed that uncured adhesives can be harmful at high concentrations or with chronic exposure.

Diisocyanates are sensitizers that are capable of causing occupational asthma. They also are highly reactive chemicals that polymerize rapidly on contact with strong alkali, mineral acids, and water. Because polymeric methylene diphenyl diisocyanate (pMDI) adhesives develop strong and durable bonds to wood, they have gained acceptance in composite wood products. Any isocyanate is potentially hazardous if mishandled, but the low vapor pressure of pMDI adhesives coupled with adequate ventilation to remove airborne pMDI on dust particles permits manufacturing plants to operate safely. Emulsion polymerized isocyanates (EPI) and polyurethanes also contain the reactive isocyanate group, and so chronic contact with these uncured adhesives should be avoided. Properly cured isocyanate adhesives are not considered hazardous in bonded wood products.

Thermoplastic adhesives are generally of low toxicity, but any added **solvents** may be toxic. Construction and contact adhesives contain organic solvents with low flash points. When used in small, unventilated spaces, the solvent can accumulate in the air and cause an explosion if ignited. Some adhesive producers offer less flammable formulations based on chlorinated solvents. Solvents in these adhesives are generally toxic, but harmful effects can be avoided by providing adequate ventilation and following the manufacturer's safety instructions.

Health and safety regulations require that toxic and hazardous chemicals have a visible label to warn of their dangers. **Material safety data sheets** (MSDS) or instructions are provided with adhesive products to advise of proper handling procedures, protective gear and clothing, and procedures for dealing with spills and fire and to offer guidance for first-aid and professional treatment of injuries. The statements made in this book concerning the safety of adhesives and effects on the health of the user are general and not meant to be all-inclusive. The user should consult the MSDS and follow the manufacturer's instructions and precautions before using any adhesive.

Bonding Process

Moisture Content Control

After wood and adhesive selection, the next most important factor contributing to trouble-free service of adhesive bonds is control of wood moisture content before and during the bonding process. Moisture content strongly affects the final strength and durability of joints, development of surface checks in wood, and dimensional stability of the bonded assembly. Large changes in moisture content after bonding

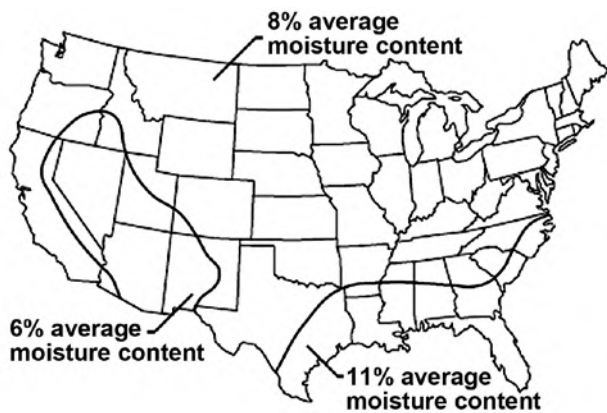

Figure 10–5. Average equilibrium moisture content (EMC) for wood in building interiors in U.S. regions.

will cause shrinking or swelling that can seriously weaken both wood and joint and can cause warping, twisting, and surface irregularities. Wood should not be bonded at high moisture content, particularly high-density wood that has a large coefficient of shrinkage, unless the in-service moisture content is also expected to be high.

The moisture content of wood products should be targeted to the equilibrium moisture content (EMC) that the product will experience in service. The regional average EMC values of wood in building interiors are shown in Figure 10–5. The average moisture content for most of the United States is 8%. Average moisture content increases to 11% along the Atlantic and Gulf coastal regions; in the arid southwest, the EMC is relatively low at 6%. The moisture content of wood outdoors averages near 12% and ranges from 7% to 14% in most of the United States. During winter in the northern states, heating of indoor air that is normally dry lowers wood EMC to 4% to 5% but can raise the moisture levels within the walls. Furniture manufactured in the southeast at 11% EMC, then sold or moved to northern states where EMC drops to 4%, may experience some splitting, delamination of joints, or other noticeable appearance defects. Manufacturers of bonded wood products must be aware of these regional and seasonal variations to condition the wood and bond it at moisture content levels consistent with regional service conditions.

Wood should be dry enough so that even if moisture is added during bonding, the moisture content of the product is at about the level expected for the assembly in service. In lumber laminates, the proportion of glue to wood is so low that a waterborne adhesive adds only 1% to 2% to the total moisture content of the laminate. In particleboard or fiberboard, however, the water in the adhesive can be 3% to 7% of the wood weight. During hot pressing, some water evaporates when the board is removed from the press; to minimize deformation and prevent steam blisters or blows, the total moisture content of the assembly should not exceed 10%. Lumber moisture content of 6% to 7%, assuming 1%

to 2% will be added by aqueous adhesives, is satisfactory for cold pressing of furniture and interior millwork. Lumber laminated for exterior use should contain 10% to 12% moisture before bonding. Moisture content of 3% to 5% in veneer at the time of hot pressing is satisfactory for hardwood plywood intended for furniture and interior millwork and for softwood plywood intended for construction and industrial uses.

Lumber that has been kiln dried to the approximate average moisture content intended for bonding may nonetheless vary in moisture content level between boards and within individual boards. Large differences in moisture content between adjacent boards result in considerable stress on the common joint as the boards equalize toward a common moisture content. Best results are achieved when differences in moisture content are not greater than about 5% for lower density species and 2% for high-density species.

Surface Preparation

The section Surface Properties of Wood for Bonding covers the detailed relationships between surface condition and adhesive bond performance. Wood surfaces are best prepared for maximum adhesive wetting, flow, and penetration by removing all materials that might interfere with bond formation to sound wood. Ideally, wood should be knife-planed within 24 h of adhesive spreading. However, other surfacing methods have been used successfully for certain types of bonded joints, including sawing for furniture and millwork, knife-cutting for veneer, and abrasive-planing for panels. All methods must produce smooth, flat, parallel surfaces, free from machining irregularities, such as burnishes, skips, and crushed, torn, and chipped grain. Properly planed flat surfaces help ensure uniform adhesive spread rate.

Spreading of Adhesive

Regardless of method used for lamination, the purpose in spreading the adhesive is to distribute uniformly an adequate amount of adhesive over the bonding area, so that under pressure, the adhesive will flow into a uniformly thin layer. The amount of adhesive needed will depend on wood species, surface quality of wood, moisture content, type of adhesive, temperature and humidity of the air, assembly time, and application of adhesive to one or both surfaces. Adhesives can be spread by hand with brush, roller, or bead-extruder, but in manufacturing, adhesives are applied mechanically, such as by roll-spreader, extruder, curtain-coater, or spray. Instead of applying a uniform film, extruders apply continuous, uniformly spaced beads of discreet diameter and flow rate (Fig. 10–6). Figure 10–7 shows the use of a pressurized extruder in the field to apply a single bead of elastomeric construction adhesive to joists for a plywood floor system.

For composite manufacturing involving flakes, strands, particles, or fibers, the adhesive is applied as a slow stream or as droplets using a spray nozzle or spinning disc, and then

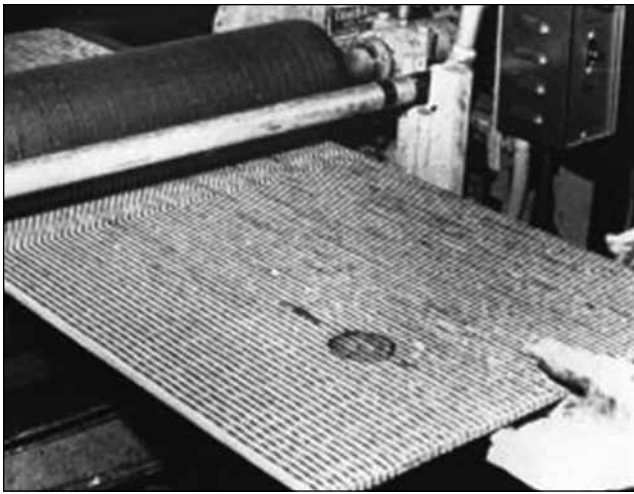

Figure 10–6. An extruder applies continuous and uniformly sized and spaced beads of adhesive to veneer for laminating into laminated veneer lumber (LVL).



Figure 10–7. A pressurized extruder applies a single bead of elastomeric construction adhesive to floor joists for assembly of a plywood floor system.

distributed with a drum blender, kneader, or tube blender. These binder adhesives hold the product together by a series of joints similar to spot welds rather than a continuous film. Microscopic analysis of droplet size and distribution illustrates adhesive distribution and its influence on board properties.

Assembly and Pressing

Adhesive viscosity is important during application, open time, closed time, and pressing. Sometimes keeping the viscosity correct throughout this process requires balancing a variety of factors. The relationship between ad-

hesive viscosity and bonding pressure is illustrated in Figure 10–8. Viscosity strongly affects wetting, flow, penetration, and, particularly, transfer of adhesive to opposing wood surfaces when pressure is applied to the assembly. Adhesive viscosity depends upon type of adhesive, type and quantity of solvent, age of adhesive mixture, and temperature. After application, adhesive viscosity will change depending on the amount of adhesive spread; species, moisture content, and temperature of wood; temperature and humidity of surrounding air; and evaporation and absorption of solvent. When the adhesive-covered surfaces remain open before assembly (open assembly), the adhesive thickens by losing solvent to the air by evaporation and to the wood by absorption. Bringing the adhesive-covered surfaces together (closed assembly) stops evaporation but not absorption. Cold-setting waterborne wood adhesives lose water by absorption and evaporation, so that viscosity steadily increases until the adhesives eventually set. Thermosetting waterborne adhesives also dry out, but they continue to flow to some extent in the presence of heat, eventually hardening by chemical reaction.

Pressure during bond assembly serves several useful purposes by

- forcing trapped air from the joint,
- bringing adhesive into molecular contact with the wood surfaces,
- forcing adhesive to penetrate into the wood structure for more effective surface adhesion and mechanical interlocking,
- squeezing the adhesive into a thin film, and
- holding the assembly in position while the adhesive cures.

If pressure is too high, however, the adhesive can be forced so deeply into (or in some cases out of) the wood that there is insufficient adhesive to fill the bondline. These conditions of overpenetration and excess squeeze-out result in a starved joint and produce inferior bond strength (Fig. 10–8). Overpenetration is especially common in low-density woods, whereas excess squeeze-out is common in high-density woods. The strongest joints are made with moderately high clamping pressure for the wood density, using adhesive with viscosity high enough to avoid overpenetration and excess squeeze-out at that pressure.

Low pressures near 0.7 MPa (100 lb in⁻²) are suitable for low-density wood because the surfaces easily conform to each other, thus ensuring intimate contact between adhesive and wood. High pressures up to 1.7 MPa (247 lb in⁻²) are required for the highest density woods, which are difficult to compress. Small areas of flat, well-planed surfaces can be bonded satisfactorily at lower pressures.

Because adhesives become thicker after they are applied to the wood and some start to cure immediately, assembly times can be very important. Some adhesives require time

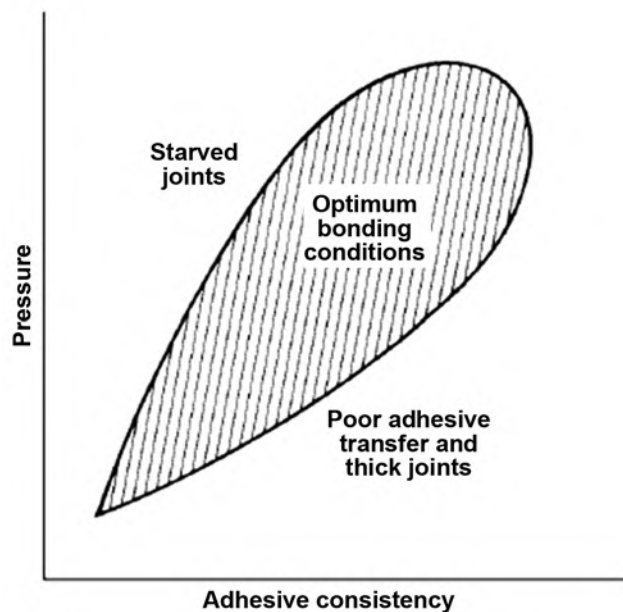

Figure 10-8. Relationship between adhesive consistency and bonding pressure for affect on bond formation using thermosetting adhesive.

before pressing to allow solvents to evaporate or adsorb into the wood, so that the adhesive is thick enough to avoid overpenetration when pressure is applied. On the other hand, adhesives that dry or cure too much before pressing do not transfer, or wet the opposite surface, resulting in thick, weak bondlines.

Bonded material should be kept under pressure until the adhesive is strong enough to resist any forces that may cause parts to shift or open gaps in the bondline. When cold-pressing lumber under normal conditions, this stage can be reached in as little as 15 min or as long as 24 h, depending on adhesive temperature and curing characteristics and the absorptive characteristics of the wood. During hot pressing, the time under pressure varies with temperature of platens, thickness of the assembly and species of wood, and adhesive formulation. Typical hot-pressing times are 2 to 15 min, and up to 30 min for very thick laminates. High-frequency heating can reduce the time under pressure to less than 3 min. High-power radio frequency energy can travel through wood but is strongly absorbed by the water in adhesives, causing selective heating of the adhesive. High-frequency curing is commonly used for bonding lumber; forming end- and edge-grain joints; patching, scarfing, and fingerjointing plywood; and manufacturing various panel products. With high frequency, press times can be shorter than 30 s, as with parquet production using 4- by 10- by 2-mm plies. Careful control of power and press time is essential to prevent arcing, or to control the more common problem of steam pressure that could blow apart the product.

With the stiff structural adhesives (phenol-, resorcinol-, melamine-formaldehyde), the strongest bonds generally

have bondlines between 0.08 and 0.15 mm (1/32 and 1/16 in.) thick. Thinner bondlines do not effectively transfer stresses, particularly stresses from moisture-induced dimensional changes. As these bondlines become thicker, they become weaker and fracture more easily. These adhesives also contain solvents, which cause the adhesive to shrink upon curing and even leave voids. Thick bondlines result from inadequate pressure or incorrect adhesive consistency. When rough, warped, or poorly mated surfaces are joined, pressure will be uneven along the bondline. As a result, the adhesive flow from the areas of very high pressure to those of little to no pressure will result in very thick bondlines. Both the starved and thick areas of the bondline lead to weak bonds.

For composites, the adhesive must have enough strength to withstand the steam pressure inside the panel as the applied press pressure is released. If the adhesive is not sufficiently strong, the internal steam pressure will cause a large delamination (blow) within the product. As the size of the composite increases, there is less relative area for steam escape and the chance of delamination increases. Dry wood, high solids adhesives, less adhesive with better distribution, and faster curing adhesives can decrease the problem of delamination.

Post-Cure Conditioning

In the process of bonding edge-grain joints, the wood in the joint absorbs moisture from the adhesive, then swells. If the bonded assembly is surfaced before this excess moisture is evaporated or absorbed uniformly, more wood is removed along the swollen joint than elsewhere. Later, when the added moisture evaporates, the wood in the joint shrinks beneath the surface. These sunken bondlines become very conspicuous under a high-gloss finish. This is particularly important when using adhesives containing large amounts of water. Moisture can be redistributed by conditioning the bonded assembly for 24 h at 70 °C (158 °F), for 4 days at 50 °C (122 °F), or at least 7 days at room temperature before surfacing. In each case, the relative humidity must be adjusted to prevent drying the wood below the target moisture content.

Conditioning to the moisture content of service is especially important for plywood, veneers, and other composites made of thin layers. During room-temperature bonding, water often needs to be removed, which can be done by controlling humidity on a time schedule. If room-temperature-bonded products are dried too much, warping, checking, and debonding increase markedly. Softwood plywood is often very dry after hot pressing, which can be corrected by spraying the hot panels and stacking them tightly to allow the moisture to diffuse uniformly. This process also restores some of the panel thickness lost by compression during hot pressing and apparently minimizes warping in service. Many composite panels need time after pressing for the adhesive to cure completely and for the moisture to equilibrate throughout the panel.

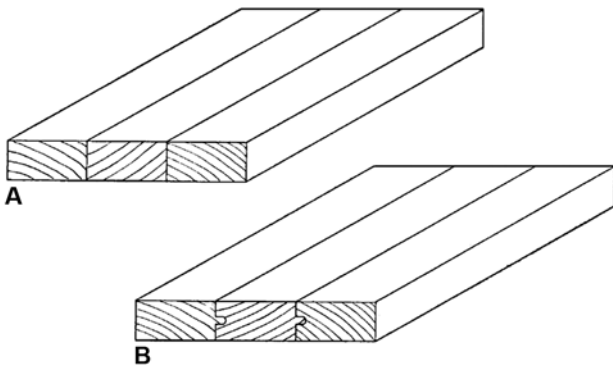

Figure 10-9. Edge-grain joints: A, plain; B, tongue-and-groove.

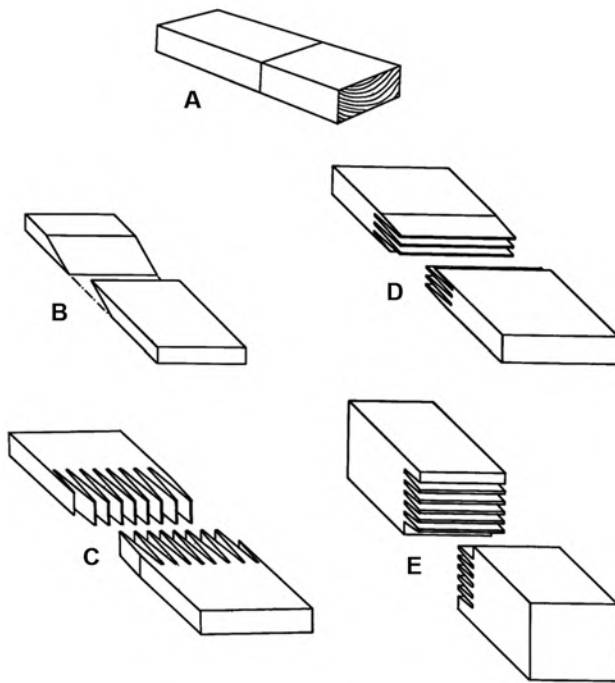

Figure 10-10. End-grain joints: A, butt; B, plain scarf; C, vertical structural fingerjoint; D, horizontal structural fingerjoint; E, nonstructural fingerjoint.

Bonded Joints

Edge-Grain Joints

Edge-grain joints (Fig. 10-9A) can be almost as strong as the wood in shear parallel to the grain, tension across the grain, and cleavage. The tongue-and-groove joint (Fig. 10-9B) and other shaped edge-grain joints have a theoretical strength advantage because of greater surface area than the straight, edge-grain joints, but they do not produce higher strength. The theoretical advantage is lost, wholly or partly, because the shaped sides of the two mating surfaces cannot be machined precisely enough to produce the perfect fit that will distribute pressure uniformly over the entire joint area. Because of poor contact, the effective

bonding area and strength can actually be less in a shaped joint than on a flat surface. Tongue-and-groove and other shaped joints have the advantage that the parts can be quickly aligned in clamps or presses. A shallow-cut tongue-and-groove is just as useful in this respect as a deeper cut, and less wood is wasted.

End-Grain Joints

It is practically impossible to make end-grain butt joints (Fig. 10-10A) strong enough to meet the requirements of ordinary service with conventional bonding techniques. Even with special techniques, butt joints reach only about 25% of the tensile strength of the wood parallel-to-grain. To approximate the tensile strength of clear solid wood, a scarf joint or fingerjoint (Fig. 10-10B-E) should have a surface area at least 10 times greater than the cross-sectional area of the piece, because wood is approximately 10 times stronger in tension than in shear. Joints cut with a slope of 1 in 12 or flatter (12 times the cross-sectional area) produce the highest strength. In plywood scarf and finger joints, a slope of 1 in 8 (8 times the cross-sectional area) is typical for structural products. For nonstructural, low-strength joints, these requirements are unnecessary.

When fingerjoints are cut with a high slope, such as 1 in 12, the tip thickness must be no greater than 0.8 mm (1/32 in.). A thickness of 0.4 to 0.8 mm (1/64 to 1/32 in.) is about the practical minimum for machined tips. Sharper tips are possible using dies that are forced into the end grain of the board.

Fingerjoints can be cut with the profile showing either on the wide face (vertical joint) (Fig. 10-10C) or on the edge (horizontal joint) (Fig. 10-10E). Vertical joints have greater area for designing shapes of fingers but require a longer cutting head with more knives. Vertical joints also cure faster than horizontal joints in high-frequency heating. A nonstructural fingerjoint, with fingers much shorter than in the two structural fingerjoints, is shown in Figure 10-10E.

A well-manufactured scarf, finger, or lap joint in end grain can have up to 90% of the tensile strength of clear wood and exhibit behavior much like that of clear wood. However, the cycles-to-failure for a well-manufactured end joint are often lower than for clear wood.

End-to-Edge-Grain Joints

It is difficult to design a plain end-to-edge-grain joint (Fig. 10-11A) capable of carrying appreciable loading. As a result, it is necessary to design these joints with interlocking surfaces so that edge grain of the interlocking piece bonds to the edge grain of the adjoining piece. Increasing the joint surface area also helps by providing more bondline to transfer load. Some examples of strong connections are dowels, mortise and tenons, and rabbets (Fig. 10-11). Because wood swells so much more across the grain than along the grain, moisture changes in these joints produce large internal stresses. All end-to-edge-grain joints should be protected from changes in moisture content in service.

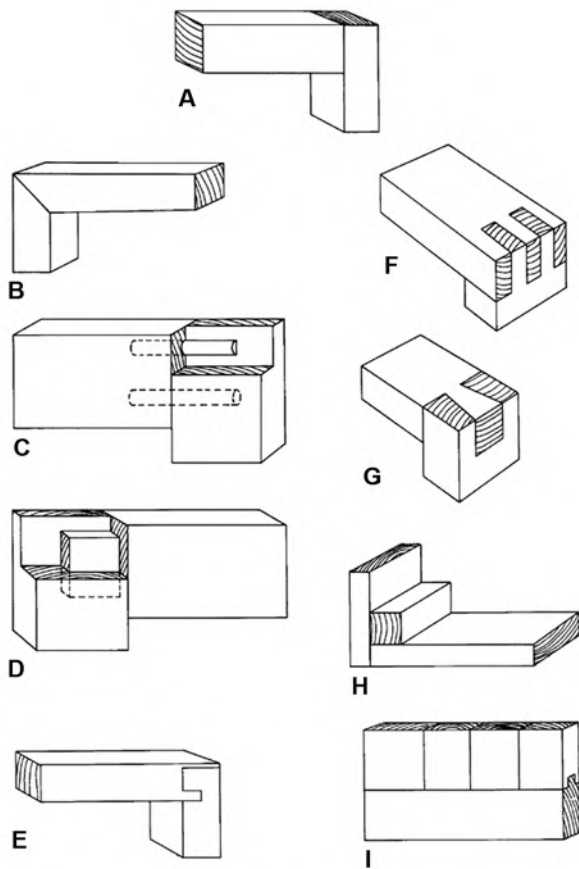

Figure 10-11. End-to-edge-grain joints: A, plain; B, miter; C, dowel; D, mortise and tenon; E, dado tongue and rabbet; F, slip or lock corner; G, dovetail; H, blocked; I, tongue-and-groove.

Construction Joints

Elastomeric construction adhesives are commonly used in the light-frame construction industry for field assembly of panelized floor and wall systems. Structural panels are bonded to floor joists and wall studs with mastic adhesives that have the unique capability of bridging gaps up to 6.5 mm (1/4 in.) between rough and poorly fitting surfaces (Fig. 10-12). Without any premixing, the adhesive is extruded in a bead along framing members with a hand-held caulking gun or a pressurized dispenser similar to that shown in Figure 10-7. Nails or screws provide the only pressure for bonding, and they hold materials in position while the adhesive sets. Elastomerics are also uniquely tolerant of the temperature and moisture content variations at field construction sites. Although they do not deliver the strength and durability of conventional structural adhesives, elastomerics are strong and flexible enough to give long-term performance under most conditions of installation and service.

Construction adhesives enable a nailed or screwed floor system to act to some degree as a composite assembly with increased stiffness. Greater stiffness permits joists to be longer and spaced more widely, with one layer of plywood



Figure 10-12. Gap-filling construction adhesive in field-assembled plywood floor system.

subflooring replacing two. Floors are less bouncy with fewer squeaks and nail pops or screw pulls. However, structural design of the composite assembly is based only on the increased stiffness of nailed or screwed panel and framing materials. The strength contributed by the adhesive cannot be factored into the engineering design but provides increased value to the homeowner.

Testing and Performance

Testing is necessary to ensure that adhesively bonded materials hold together within a given service environment for the life of the structure. Many methods are available to test bonding performance, particularly for bonded assemblies. Generally, these testing methods attempt to predict how bonded joints are likely to perform in a specific loading mode (shear, tensile, creep) in an assembly at specific temperature and moisture conditions for a specific time.

Most performance tests are short term. They are based on chemical, mechanical, and rheological laboratory tests of adhesive polymers, adhesives, and bonds. Intermediate-term tests of products that are conducted in pilot operations and field experiments are integrated with short-term laboratory tests in an effort to extrapolate these data into long-term performance. Long-term tests of bonded assemblies under actual environmental exposures are conducted, but this information may not be available for 10 to 30 years. Therefore, short-term tests are extensively used to predict long-term performance. As we learn the relationships between chemical structure and mechanical performance, and as companies are under continued pressure to launch new products, the reliance on short-term testing is increasing.

Analytical, Chemical, and Mechanical Testing of Polymers

Although many methods of characterizing adhesives are available, this section only briefly mentions some of the most important and common methods.

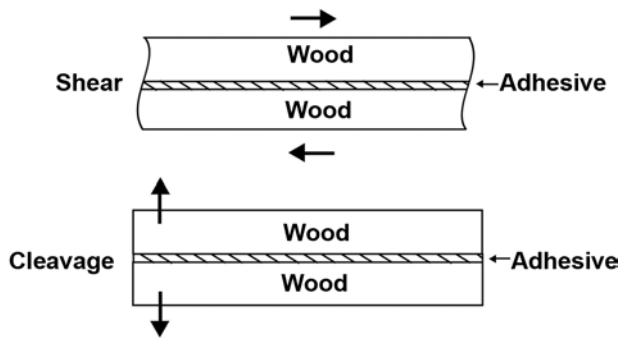

Figure 10–13. Failure modes of adhesive bonds.

Nuclear magnetic resonance (NMR) spectroscopy and other spectroscopic techniques help characterize the molecular structures of adhesive polymers. Molecular size distribution is commonly measured by gel permeation chromatography (GPC), also known as size exclusion chromatography (SEC). Differential scanning calorimetry (DSC) and gel times provide information on rates of chemical curing reactions. The rheological properties of curing and cured adhesives are characterized by dynamic mechanical analysis (DMA) and torsional-braid analysis (TBA). Sophisticated fracture mechanics techniques are used to measure toughness of adhesive bonds as they fail in a cleavage mode. High-magnification microscopes, including scanning electron microscope, transmission electron microscope, and atomic force microscope, enable scientists to see wood and adhesive surfaces in minute detail before, during, and after fracture. Fluorescent and confocal microscopes provide excellent information on adhesive distribution, adhesive penetration, and bond fracture surfaces because of their ability to distinguish between wood and adhesive.

Although much can be learned from measurements of chemical, mechanical, and rheological properties of polymers and adhesives before their application to wood, no correlation between laboratory test and product performance is perfect. There is no substitute for testing performance in bonded assemblies prepared with specific adhesives and materials and tested under specific loading modes, environmental conditions, and duration of loading. When adhesives are formulated through a blend of scientific analysis and art of formulation, they are tested for strength and durability in the laboratory and field, usually by industry-accepted standard test methods and product specifications.

Mechanical Testing of Bonded Assemblies

In an attempt to promote communication and understanding, there are many standardized test methods for evaluating and comparing the performance of different materials. Most test methods, specifications, and practices for adhesives and bonded assemblies are consensus standards. ASTM International publishes a book of standard methods each year (ASTM [Current edition]). Several trade associations have

their own specifications and performance standards that apply to their specific wood products. The Federal government also has specifications that are used by the General Services Administration to purchase products. In all test modes, specific materials, conditions of materials and testing, and testing procedures are completely specified to ensure repeatability and enable valid comparisons of data.

Two basic failure modes, shear and cleavage, are commonly used to test adhesive bonds to determine strength levels during impact, flexure, fatigue, and creep under long-term stress (Fig. 10–13). The following describes the basic stress modes in adhesive-bonded joints:

- Shear, resulting from forces applied parallel to the bondline, either in compression or tension
- Cleavage, resulting from forces applied perpendicular to the bondline. These forces may be applied by a wedge or other crack-opening device, by pulling on a double cantilever beam, or by pulling two faces apart, such as in a section of particleboard. Tensile loads often result in cleavage failures.

As the names imply, impact, fatigue, and creep are tests that pertain to the rate at which loads are applied. Standard testing is done so that load continues to increase until failure, typically occurring between 1 and 5 min. Impact loads are sudden; for example, hitting a specimen with a swinging arm. Fatigue is the loss in strength from repeated loading and unloading to reflect bond deterioration from mechanical stresses. Sometimes, environmental stresses such as moisture and temperature are added as well. Creep loads are static loads applied for long times, from a few days to years, usually under extreme environmental conditions.

The common measures used to estimate potential performance of bonded wood joints are strength, wood failure, and delamination. The highest performance level after exposure to severe environmental conditions is bond strength greater than wood strength, wood failure in more than 85% of the bonded area, and less than 5% or 8% delamination of the joint, for softwoods and hardwoods, respectively. These performance values reflect how wood, adhesive, and environmental exposure interact in response to loading.

Exceeding the strength of wood is an essential performance criterion, often more important than measured shear strength. Percentage wood failure is the amount of wood that fails as a percentage of the area of the bonded joint. In general, strong and durable bonds give high wood failure and fracture deep into the grain of the wood. If wood failure is shallow with only wood fibers remaining attached to the adhesive film, bond strength and probably durability are lacking. Thus, a consistently high level of wood failure, above 75% in some standards and above 85% in others, means that the shear strength associated with these bonds is a good estimate of the load-carrying capability of the joint.

High levels of wood failure in a wet and hot environment suggest that the adhesive bond is as strong as the wood. If cycles of alternate wetting and drying were included with cycles of wet and hot conditions, then high wood failure would indicate even more durable bonds. High wood failure in shear tests of water-saturated bonds is also a strong indicator of bond durability. Wood failure is considered a valid measure of bond strength only to solid wood, not to reconstituted products made of bonded wood particles.

High shear strength and high wood failure are not sufficient indicators of bond durability. Delamination is an indicator of how well the bonded joint withstands severe swelling and shrinking stresses in the presence of high moisture and heat. Delamination is the separation between laminates because of adhesive failure, either in the adhesive or at the interface between adhesive and wood. If adhesives are able to resist delaminating forces, any wood failure will occur adjacent to the bondline, but not within the adhesive. Delamination of adhesives in structural laminated wood products exposed to the cyclic delamination test in ASTM D 2559 cannot exceed 5% in softwoods and 8% in hardwoods.

Bonds in structural assemblies are expected to exceed the strength of the wood, so in traditional design of joints, adhesive strength has been ignored. Traditionally, adhesives that are not as strong as the wood simply have not been used in structural applications because methods for determining allowable mechanical properties of adhesives for engineering design had not been developed. One such method now exists—ASTM D 5574.

Short- and Long-Term Performance

In the short term, mechanical properties of wood, adhesives, and bonded products vary with specific environmental exposure. In most cases, all properties decrease as temperature and moisture levels increase. Strength and stiffness may return to their original levels if the yield points of the materials are not exceeded while under load. Wood properties degrade faster under heat and moisture than do rigid thermosetting adhesives like resorcinol-, phenol-, and melamine-formaldehyde, but this is not true for urea-formaldehyde. Therefore, evaluating short-term performance of products made with these adhesives is simply a matter of testing bonds at room temperature in dry and wet conditions. With increased moisture and/or heat, thermoplastic adhesives such as poly(vinyl acetate), elastomers, hot-melts, pressure-sensitive adhesives, soy and casein tend to lose stiffness and strength more rapidly than does wood. These adhesives must be tested dry, dry after water soaking, and after prolonged exposure to high humidity environments. In addition, some specifications require testing bonded structural and nonstructural products at elevated temperatures similar to what might be encountered in roofs or enclosed shipping containers. A short-term dead-load test at elevated temperatures may also be required. Adhesive specifications for structural products such as laminated beams and

plywood require high minimum strength and wood failure values after several different water exposure tests. Adhesive bonds in laminated beams must show very little delamination after exposure to severe cyclic moisture content and temperature changes.

Long-term deterioration of wood, adhesives, and bonded products is determined by the levels of temperature, moisture, and stress, and, in some instances, by concentrations of chemicals and presence of microorganisms. Long-term performance is the ability of a product to resist loss of a measured mechanical property over the time of exposure. A durable bonded product is one that shows no greater loss of properties during its life in service than does solid wood of the same species and quality.

Many adhesives in bonded products have decades of documented performance in many environments. Thus, it is possible to predict with a high degree of certainty the long-term performance of similar products. Well-designed and well-made joints with any of the commonly used wood-working adhesives will retain their strength indefinitely if the moisture content of the wood does not exceed approximately 15% and if the temperature remains within the range of human comfort. However, some adhesives deteriorate when exposed either intermittently or continuously to temperatures greater than 38 °C (100 °F) for long periods. Low temperatures seem to have no significant effect on strength of bonded joints.

Products made with phenol-formaldehyde, resorcinol-formaldehyde, and phenol-resorcinol-formaldehyde adhesives have proven to be more durable than wood when exposed to warm and humid environments, water, alternate wetting and drying, and even temperatures high enough to char wood. These adhesives are adequate for use in products that are exposed to the weather indefinitely (Fig. 10–14).

Well-made products with melamine-, melamine-urea-, and urea-formaldehyde resin adhesives have proven to be less durable than wood. Melamine-formaldehyde is only slightly less durable than phenol-formaldehyde or resorcinol-formaldehyde and is considered acceptable for structural products. Although considered less durable, melamine-urea-formaldehyde is also accepted in structural products at a melamine:urea ratio of 60:40. Urea-formaldehyde resin is susceptible to deterioration by heat and moisture (Fig. 10–14).

Products bonded with poly(vinyl acetate) and protein-based adhesives will not withstand prolonged exposure to water or repeated high–low moisture content cycling in bonds of high-density woods. However, if properly formulated, these adhesives are durable in a normal interior environment. The use of poly(vinyl acetate) adhesives is prohibited for some structural applications.

Some isocyanate, epoxy, polyurethane, emulsion polymer isocyanates, and cross-linked poly(vinyl acetate) adhesives

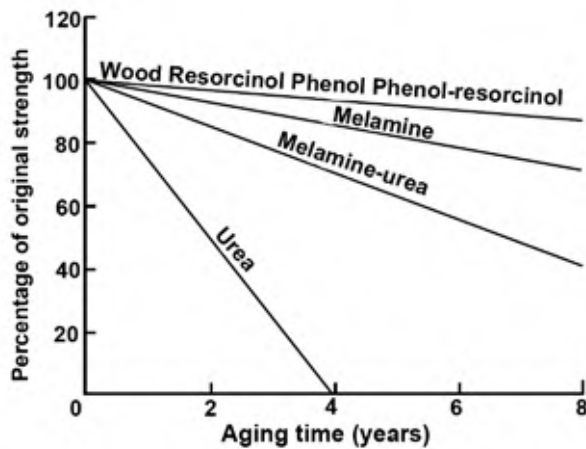

Figure 10–14. Relative rates of deterioration of bond strength of small specimens exposed directly to weather.

are durable enough to use on lower density species even under exterior conditions, but for most of these adhesives, exterior exposure must be limited. Some elastomer-based adhesives may be durable enough for limited exposure to moisture with lower density species in nonstructural applications or in structural applications when used in conjunction with approved nailing schedules. Polyurethane adhesives that chemically cure and remain flexible are among the most durable construction adhesives.

New adhesives do not have a history of long-term performance in service environments, so accelerated laboratory exposures that include cycles of heat, moisture, and stress are used to estimate long-term performance. However, laboratory exposures cannot duplicate the actual conditions of a service environment. Estimates of long-term performance can be obtained by exposing specimens outdoors for up to 30 years. Outdoor exposures may be intensified by facing specimens south at an angle perpendicular to the noonday sun and by establishing exposure sites in regions with the most extreme service environments, for example, southern coastal and arid southwestern regions. Only four long-term laboratory aging methods have been standardized, and none specifies minimum performance levels because the bonded product is the item that must meet code standards. Therefore, performance of any new adhesive or bonded product must be compared with performance of established adhesives or products tested in the same laboratory exposure.

Product Quality Assurance

After the short- and long-term performance of a product has been established, maintenance of the manufacturing process to ensure that the product will be made and perform at that level is the major concern of a quality-assurance program, which consists of three parts:

1. Establishing limits on bonding process factors that will ensure acceptable joints and product

2. Monitoring production processes and bond quality in joints and product
3. Detecting unacceptable joints and product, determining the cause, and correcting the problem

The structural panel, laminated-beam, particleboard, mill-work, and other industrial trade associations have established quality-assurance programs that effectively monitor the joint and product performance at the time of manufacture for compliance with voluntary product standards. Product performance is usually evaluated immediately after manufacture by subjecting specimens from the product to a series of swell–shrink cycles. The treatments are more rigorous for products intended for exterior exposure. For example, exterior softwood plywood is subjected to two boil–dry cycles, while interior plywood is subjected to a single soak–dry cycle at room temperature. After exposure, specimens are evaluated for delamination, percentage wood failure, or both. Test results are compared with the minimum requirement in the trade association’s standards. Lengthy experience and correlations between exterior performance and accelerated laboratory tests have shown that products with at least the minimum values will probably perform satisfactorily in service. If the product meets the requirement, it is certified by the association as meeting the standard for satisfactory performance.

Standards

AITC. [Current edition]. Inspection manual for structural glued laminated timber, AITC 200. Englewood, CO: American Institute of Timber Construction.

ANSI/AITC. [Current edition]. American national standard for wood products–structural glued laminated timber, ANSI/AITC A190.1. Englewood, CO: American Institute of Timber Construction.

APA. [Current edition]. Performance standards and policies for structural-use panels, APA PRP–108. Tacoma, WA: APA–The Engineered Wood Association.

APA. [Current edition]. U.S. product standard PS1-07 for construction and industrial plywood with typical APA trademarks. Tacoma, WA: APA–The Engineered Wood Association.

ASTM. [Current edition]. Annual book of ASTM standards, Vol. 15.06 Adhesives. West Conshohocken, PA: American Society for Testing and Materials. *Many of the standards are related to wood bonding for specific types of applications.*

CPA. [Current edition.] Particleboard, ANSI A208.1. Leesburg, VA: Composite Panel Association.

CPA. [Current edition]. Medium density fiberboard. ANSI A208.2. Leesburg, VA: Composite Panel Association.

Hardwood Plywood & Veneer Association. [Current edition]. American national standard for hardwood and decorative plywood, ANSI/HPVA HP-1. Reston, VA.

References

- Blomquist, R.F.; Christiansen, A.W.; Gillespie, R.H.; Myers, G.E., eds. 1984. Adhesive bonding of wood and other structural materials. Clark C. Heritage memorial series on wood, Vol. 3. Educational modules for material science and engineering (EMMSE). University Park, PA: Pennsylvania State University. 436 p.
- Blomquist, R.F.; Vick, C.B. 1977. Adhesives for building construction. In: Skeist, I., ed. Handbook of adhesives, 2nd ed. New York, NY: Van Nostrand Reinhold Company.
- Bryant, B.S. 1977. Wood adhesion. In: Skeist, I., ed. Handbook of adhesives, 2nd ed. New York, NY: Van Nostrand Reinhold Company. 25 p.
- Caster, R.W. 1980. Correlation between exterior exposure and automatic boil test results. In: John, W.E.; Gillespie, R.H., eds. Proceedings of a symposium, Wood adhesives—research, application, needs; 1980 September 23–25; Madison, WI: U.S. Department of Agriculture, Forest Service, Forest Products Laboratory.
- Christiansen, A.W. 1990. How overdrying wood reduces its bonding to phenol-formaldehyde adhesives: a critical review of the literature. Part I. Physical responses. Wood Fiber Science. 22(4): 441–459.
- Christiansen, A.W. 1991. How overdrying wood reduces its bonding to phenol-formaldehyde adhesives: a critical review of the literature. Part II. Chemical reactions. Wood Fiber Science. 23(1): 69–84.
- Collett, B.M. 1972. A review of surface and interfacial adhesion in wood science and related fields. Wood Science Technology. 6(1): 1–42.
- Dunky, M. 2003. Adhesives in the wood industry. In: Pizzi, A.; Mittal, K.L., eds. Handbook of adhesive technology, 2nd ed. 887–956.
- Dunky, M.; Pizzi, A. 2003. Wood adhesives. In: Dillard, D.A.; Pocius, A.V., eds. Adhesion science and engineering, Vol. 2: Issue surfaces, chemistry and applications. 1039–1103.
- Frihart, C.R. 2005. Wood adhesion and adhesives. In: Rowell, R.M., ed. Handbook of wood chemistry and wood composites. Boca Raton, FL: Taylor & Francis. 215–278.
- Gillespie, R.H. 1965. Accelerated aging of adhesives in plywood-type joints. Forest Products Journal. 15(9): 369–378.
- Gillespie, R.H. 1981. Wood composites. In: Oliver, J.F., ed. Adhesion in cellulose and wood-based composites. New York: Plenum Press. 167–189.
- Gillespie, R.H.; River, B.H. 1975. Durability of adhesives in plywood: dry-heat effects by rate-process analysis. Forest Products Journal. 25(7): 26–32.
- Gillespie, R.H.; River, B.H. 1976. Durability of adhesives in plywood. Forest Products Journal. 26(10): 21–25.
- Gillespie, R.H.; Countryman, D.; Blomquist, R.F. 1978. Adhesives in building construction. Agric. Handb. 516. Washington, DC: U.S. Department of Agriculture, Forest Service. 165 p.
- Hoyle, R.J. 1976. Designing wood structures bonded with elastomeric adhesives. Forest Products Journal. 26(3): 28–34.
- Jarvi, R.A. 1967. Exterior glues for plywood. Forest Products Journal. 17(1): 37–42.
- Jokerst, R.W. 1981. Finger-jointed wood products. Res. Pap. FPL–RP–382. Madison, WI: U.S. Department of Agriculture, Forest Service, Forest Products Laboratory. 24 p.
- Lambuth, A.L. 1977. Bonding tropical hardwoods with phenolic adhesives. In: Proceedings, IUFRO meeting on processing of tropical hardwoods. 1977 October 2–9; Merida, Venezuela: Laboratorio Nacional de Productos Forestales.
- Marra, A.A. 1980. Applications of wood bonding. In: R.F. Bloomquist, A.W. Christiansen, R.H. Gillespie, and G.E. Myers, eds. Adhesive bonding of wood and other structural materials, Chapter IX. EMMSE Project, Pennsylvania State University, University Park, PA. 365–418.
- Marra, A.A. 1992. Technology of wood bonding—principles in practice. New York, NY: Van Nostrand Reinhold. 454 p.
- McGee, W.D.; Hoyle, R.J. 1974. Design method for elastomeric adhesive bonded wood joist-deck systems. Wood Fiber Science. 6(2): 144–155.
- Miller, R.S. 1990. Adhesives for building construction. In: Skeist, I., ed. Handbook of adhesives, 3rd ed. New York, NY: Van Nostrand Reinhold Company.
- Murmanis, L.; River, B.H.; Stewart, H.A. 1986. Surface and subsurface characteristics related to abrasive-planing conditions. Wood Fiber Science. 18(1): 107–117.
- Pizzi, A., ed. 1983. Wood adhesives chemistry and technology. New York, NY: Marcel Dekker, Inc. 364 p. Vol. 1.
- Pizzi, A., ed. 1989. Wood adhesives chemistry and technology. New York, NY: Marcel Dekker, Inc. 416 p. Vol. 2.
- Pizzi, A. 1994. Advanced wood adhesives technology. New York, NY: Marcel Dekker, Inc. 304 p.
- Pizzi, A.; Mittal, K.L. 2003. Handbook of adhesive technology. 2nd ed. New York, NY: Marcel Dekker, Inc. 672 p.
- River, B.H. 1973. Mastic construction adhesives in fire exposure. Res. Pap. FPL–RP–198. Madison, WI: U.S.

- Department of Agriculture, Forest Service, Forest Products Laboratory. 16 p.
- River, B.H. 1981. Behavior of construction adhesives under long-term load. Res. Pap. FPL–RP–400. Madison, WI: U.S. Department of Agriculture, Forest Service, Forest Products Laboratory. 16 p.
- River, B.H. 1984. Accelerated, real-time aging for 4 construction adhesives. *Adhesives Age*. (2): 16–21.
- River, B.H. 1994. Fracture of adhesive-bonded wood joints. In: Pizzi, A; Mittal, K.L., eds. *Handbook of adhesive technology*. New York, NY: Marcel Dekker, Inc. 27 p. Chapter 9.
- River, B.H.; Okkonen, E.A. 1991. Delamination of edge-glued wood panels—moisture effects. Res. Note FPL–RN–0259. Madison, WI: U.S. Department of Agriculture, Forest Service, Forest Products Laboratory. 11 p.
- River, B.H.; Gillespie, R.H.; Vick, C.B. 1991. Wood as an adherend. In: Minford, J.D., ed. *Treatise on adhesion and adhesives*. New York, NY: Marcel Dekker, Inc. 230 p. Vol. 7.
- Selbo, M.L. 1975. Adhesive bonding of wood. Tech. Bull. 1512. Washington, DC: U.S. Department of Agriculture, Forest Service. 129 p.
- Sellers, T., Jr. 1985. *Plywood and adhesive technology*. New York, NY: Marcel Dekker, Inc. 661 p.
- Skeist, I., ed. 1977. *Handbook of adhesives*. 2nd ed. New York, NY: Van Nostrand Reinhold. 921 p.
- Skeist, I., ed. 1990. *Handbook of adhesives*. 3rd ed. New York, NY: Van Nostrand Reinhold. 779 p.
- Vick, C.B. 1971. Elastomeric adhesives for field-gluing plywood floors. *Forest Products Journal*. 21(8): 34–42.
- Vick, C.B. 1994. Phenolic adhesive bonds to aspen veneers treated with amino-resin fire retardants. *Forest Products Journal*. 44(1): 33–40.
- Vick, C.B. 1995. Coupling agent improves durability of PRF bonds to CCA-treated Southern Pine. *Forest Products Journal*. 45(3): 78–84.
- Vick, C.B. 1996. Hydroxymethylated resorcinol coupling agent for enhanced adhesion of epoxy and other thermosetting adhesives to wood. In: Christiansen, A.W.; Conner, A.H., eds. *Wood adhesives 1995. Proceedings of a symposium; 1995 June 29–30; Portland, OR*. Proc. 7296. Madison, WI: Forest Products Society.
- Vick, C.B.; Rowell, R.M. 1990. Adhesive bonding of acetylated wood. *International Journal of Adhesion and Adhesives*. 10(4): 263–272.
- Vick, C.B.; DeGroot, R.C.; Youngquist, J. 1990. Compatibility of nonacidic waterborne preservatives with phenol-formaldehyde adhesive. *Forest Products Journal*. 40(2): 16–22.